

Engel Injection Molding Machine

INSERT 600H/150 WP US - VERTICAL CLAMP / HORIZONTAL INJECTION

CLAMP

Clamp force	US tons	150
Clamp opening force	US tons	14
Clamp stroke (max.)	inches	15.75
Mold height (min - max)	inches	15.75 ⁵ - N/A
Daylight (min - max)	inches	15.75 ⁵ - 31.50
Platen size (HxV)	inches	39.37 x 25.90

ROTARY TABLE

Rotary table diameter	inches	62.00
Mold pitch circle diameter	inches	35.83
Hydraulic ejector stroke	inches	5.9
Ejector penetration (above table)	inches	3.0
Hydraulic ejector force	US tons	4.3

INJECTION 600

Screw diameter	mm	40	45	50
Screw diameter	inches	1.575	1.772	1.969
Shot size ¹⁺²	oz	8.2	10.3	12.7
Injection capacity	in ³	15.3	19.4	24.0
Recovery rate ¹⁺²	oz/sec	0.8	1.1	1.5
Plasticizing capacity ¹⁺²	lbs/hr	186	246	334
Injection rate at max. press. ³⁺⁴	in ³ /sec	6.4	8.2	10.1
Injection rate (regenerative) ³⁺⁴	in ³ /sec	8.7	11.1	13.7
Injection velocity at max. press. ³⁺⁴	in/sec	3.3		
Injection velocity (regenerative) ³⁺⁴	in/sec	4.5		
Screw stroke	inches	7.87		
Injection pressure (max.) ⁴	psi	30000	27173	22011
Injection pressure (regenerative) ⁴	psi	22129	20043	16236
Screw speed range (min=25)	rpm	297		
Screw torque ⁴	ft-lbs	514		
Screw L/D ratio		20:1		
Nozzle stroke	inches	15.8		
Nozzle reach to mold center	inches	5.0		
Nozzle force	US tons	4.0		
Nozzle height (min-max) ⁴	inches	5.0 - 12.0		

HYDRAULICS

Pump capacity (required)	gpm	24.8
Oil reservoir capacity	US gal	106

ELECTRICS

Power supply available	volts	460 / 575 - 3PH / 60Hz
Total rated horsepower	HP	30
Number of heat control zones		4+Nozzle
Total heating wattage	kw	9.1 10.7 11.7

GENERAL

Water requirements (max)	gpm	10
Machine dimensions (LxWxH)	inches	200 x 115 x 130
Machine weight	lbs	37400
Hopper capacity	lbs	163
Suitable Engel robots		ERC 23, ERV 31

NOTES:

1. Based on polystyrene material.
2. Calculated
3. Can be increased with accumulator.
4. Can be increased.
5. Smaller mold height settings optional

All data subject to change without notice
Issue Date: 10/30/02

INSERT 600H/150 WP US
VERTICAL CLAMP
Data Sheet

ENGEL

STANDARDS & OPTIONS

STANDARD EQUIPMENT

Injection

- Nitrided barrel and screw
- Non-return ring check valve
- 10 step injection speed profiling
- 10 step holding pressure profiling
- 5 step back pressure profiling
- 5 step screw speed profiling
- Digital screw speed (RPM) display
- Digital injection time monitoring
- Screw recovery time monitoring
- Boost cut-off: time, stroke and hydraulic pressure dependent (switch-over by cavity pressure is optional)
- Automatic cushion monitoring and control
- Cold start protection
- Injection unit swivel
- Quick barrel change (80cc-330cc)
- Precision linear bearings for carriage movement
- Hopper discharge chute
- Feedthroat prepared for water-cooling
- Feedthroat with thermometer
- Quick disconnects for heater bands (80cc-330cc)
- Increased injection pressure (via regenerative circuit, screen selectable)
- Programs for sprue break, decompression, and intrusion
- Pneumatic purge shield
- Single-point nozzle height adjustment

Clamp

- Pneumatically actuated safety gate
- Rigid bridge-type frame
- Mechanical safety dropbar
- 3 speed opening and closing
- Hydraulic and electric safety gate interlocks
- Direct hydraulic clamp with integral quick close cylinder
- Precision linear bearings for platen stroke
- Moving platen prepared for water cooling
- 5 speed / pressure / position mold protection
- Hydraulic counterbalance circuit
- Automatic clamp force control

Rotary Table

- Rigid base plate for full table support
- Lifting table design for minimal wear
- Precise table positioning via "shot pin" locating mechanism
- Multi-stroke hydraulic ejection, proportional speed control, independent of injection/screw feed
- 2-position reciprocating 180 deg. table

Hydraulics

- Fully proportional linearized hydraulic system
- Automatic calibration of proportional hydraulic valves and transducers
- Clogged filter indicator
- Closed loop oil temperature regulation with pre-warming system

Hydraulics (continued)

- Oil level indicator with level switch
 - Pressure selector gauge
 - Pressure compensated variable displacement pumps
 - Energy efficient totally enclosed fan-cooled motors
- #### Controls, Electrics & Electronics
- Microprocessor control with high resolution flat color screen
 - RISC Multiple processor architecture (distributed intelligence)
 - Built-in disk drive for data up/down loading
 - Mold set-ups via machine CPU
 - Quick machine set up via single screen
 - Linear transducers for measurement of the clamp, injection, carriage and ejector positions
 - Automatic cycle monitoring
 - Digital display of actual values
 - Current function display
 - Self-diagnostics, monitoring, alarms
 - Automatic screen shut-off
 - Automatic balancing of heat zones during warm-up
 - Auto barrel stand-by temperature when machine in alarm condition
 - Automatic reject signal
 - US/metric units conversion (instant changeover)
 - User-defined programmable text pages. Keyboard extra.
 - Self-tuning temperature controls
 - History reporting of alarm conditions and set-up changes
 - Resettable cycle and non-resettable hour counters
 - Interface port for external data carrier and calibration
 - Anti-tie down cycle start safety palm buttons
 - Pivoting cabinet for operator interface and display

OPTIONAL EQUIPMENT

Injection

- Hardened screws and bi-metallic barrels
- Specialty screws and screw tips for a wide variety of applications
- LIM, Thermoset, PVC, BMC, PIM, Gasmelt, MuCell and other packages
- Increased wattage & air-cooled heater bands
- Shut-off nozzles
- Insulating blanket for barrel
- Hopper or drawer magnets
- Automatic motorized nozzle height adjustment

Clamp

- 3 or 4 mold stations with rotary union for mold water cooling at table center
- Hydraulic quick mold mounting system (moving platen only)
- Safety key switch for entry during ejector and core movement

Clamp (continued)

- Air blow-off valve
- Infrared light curtain in place of safety gate
- Positive return of mold ejector
- Hydraulic ejector on moving platen
- Additional fixed ejector
- Hot fluid connections through rotary union at table center
- Corepull(s) and unscrewing control
- Mold venting program
- Reduced minimum mold height

Hydraulics

- Servo valve for closed loop injection speed, injection pressure, and screw back pressure control
- Increased hydraulic drive for increased plasticizing and injection speeds
- Accumulator system for increased injection speed or special functions
- Hot runner valve gate control (pneumatic or hydraulic)
- High torque screw drive
- By-pass oil filtration

Controls, Electrics & Electronics

- CC100 Microprocessor control with high resolution color screen
- Microplast and Microflow software packages
- Process data graphics and reports
- SPC (Quality data Statistics)
- Automatic barrel/nozzle heat-up (7 day, 24 hour timer)
- Power factor capacitors
- Robot interface
- Auxiliary electrical receptacles
- Host computer and SPI auxiliary device interface
- Automatic shut-down for "lights-out" operation (ghost-shift program)
- Hot runner PID temperature controls
- Melt temperature or pressure monitors
- Closed loop feedthroat cooling
- Cavity pressure dependent boost cut-off
- Graphics printer
- Power supply available: 230/460/575 volts, 3Ph/60Hz
- Ammeters for barrel and nozzle zones
- Electrical input for insert confirmation
- Electrical rotary commutator for mold temp. control connections at table center

General

- Machine levelling/vibration mounts
- Waterflow controls
- Special painting of machine to customer's specifications
- Alarm sounder in addition to standard alarm light
- Spare parts packages
- Engel robots
- Training programs

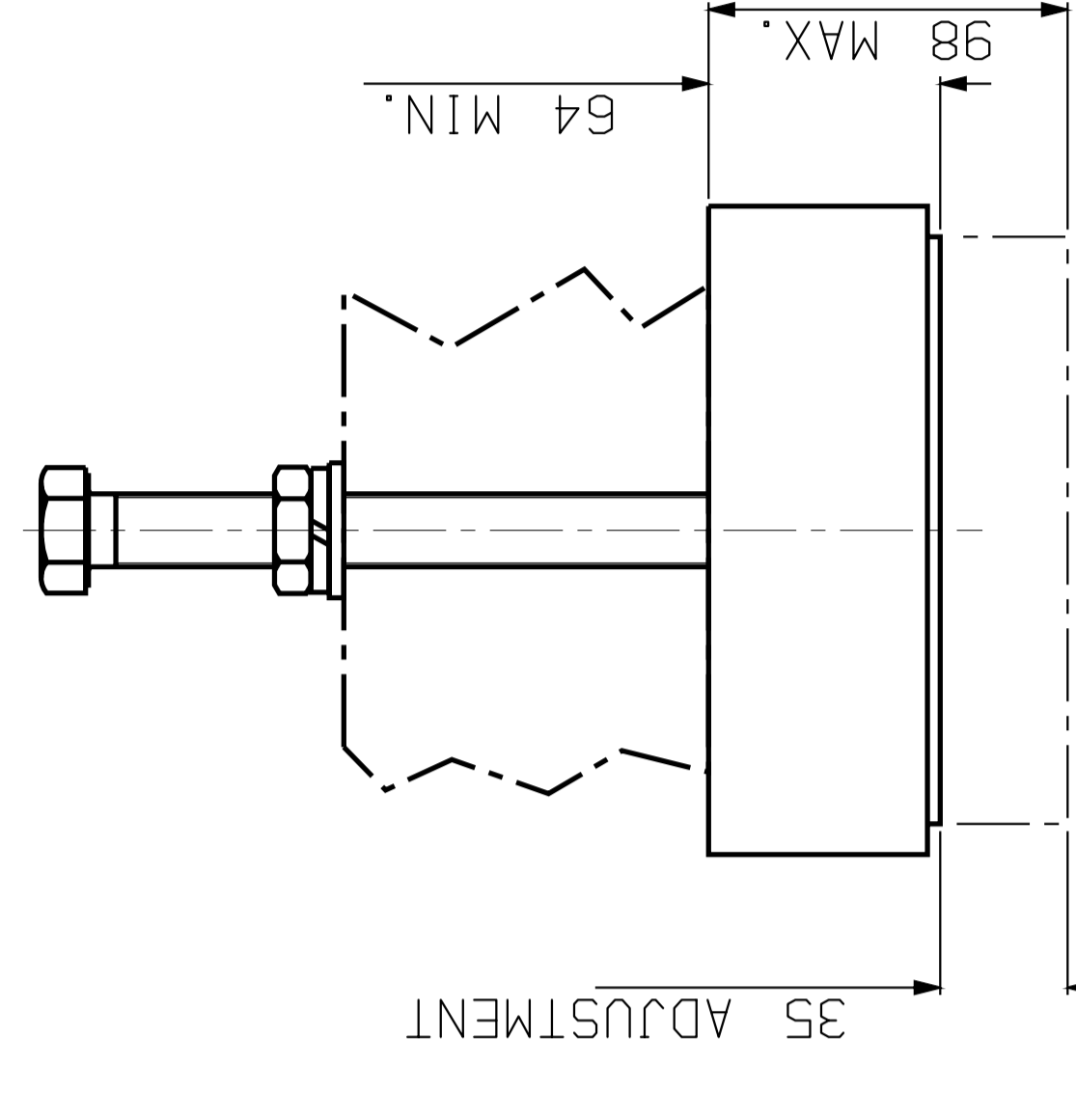
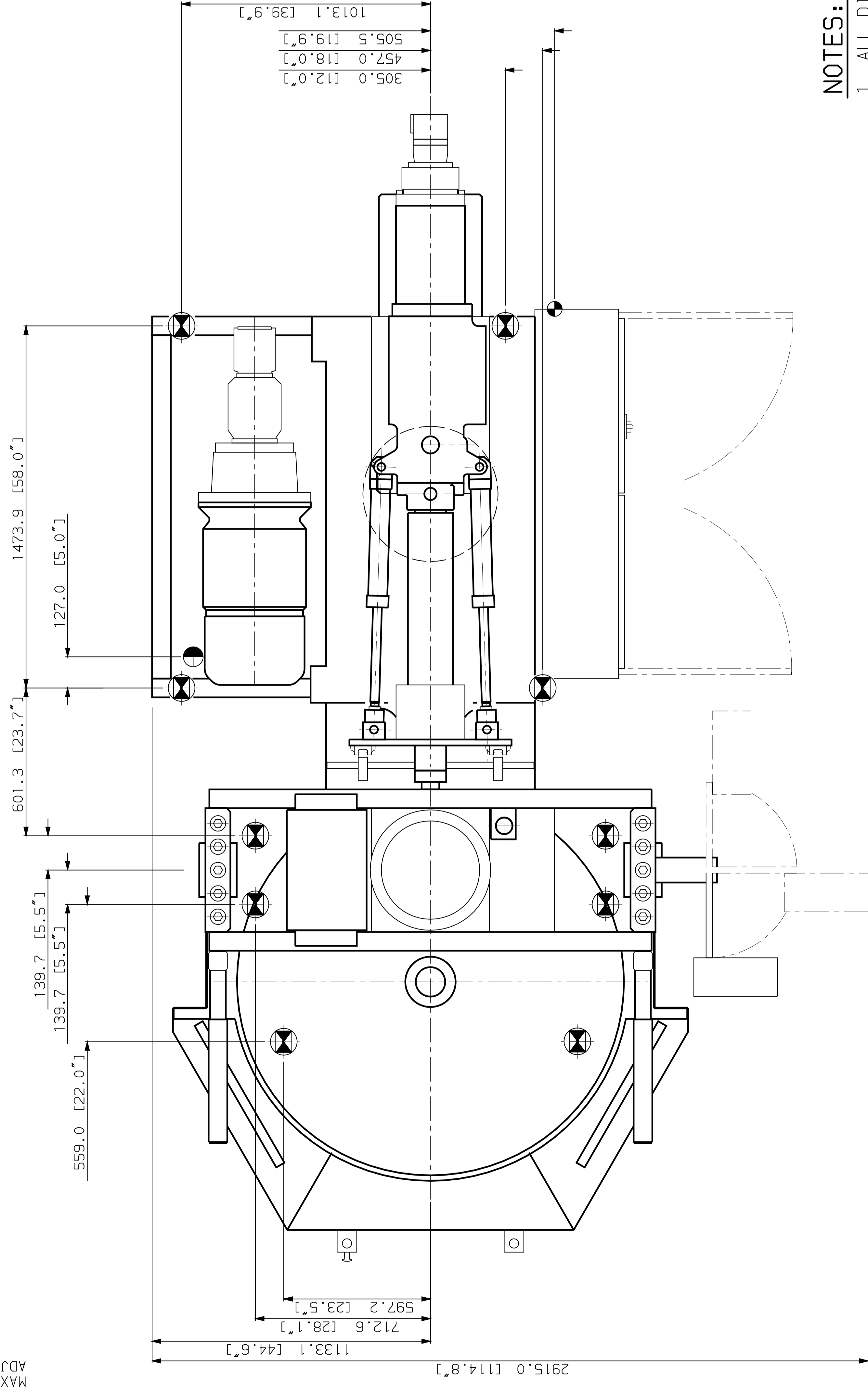
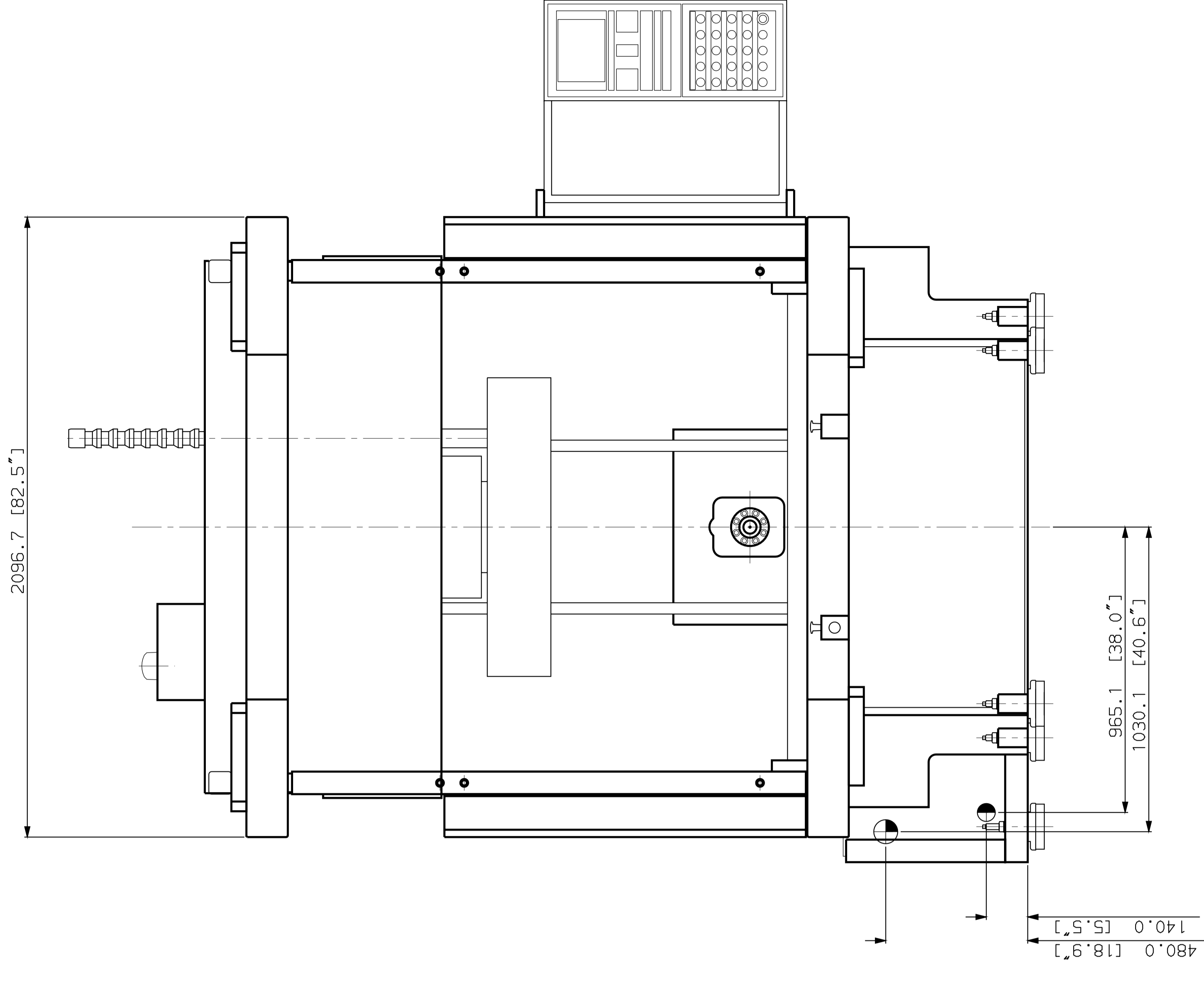
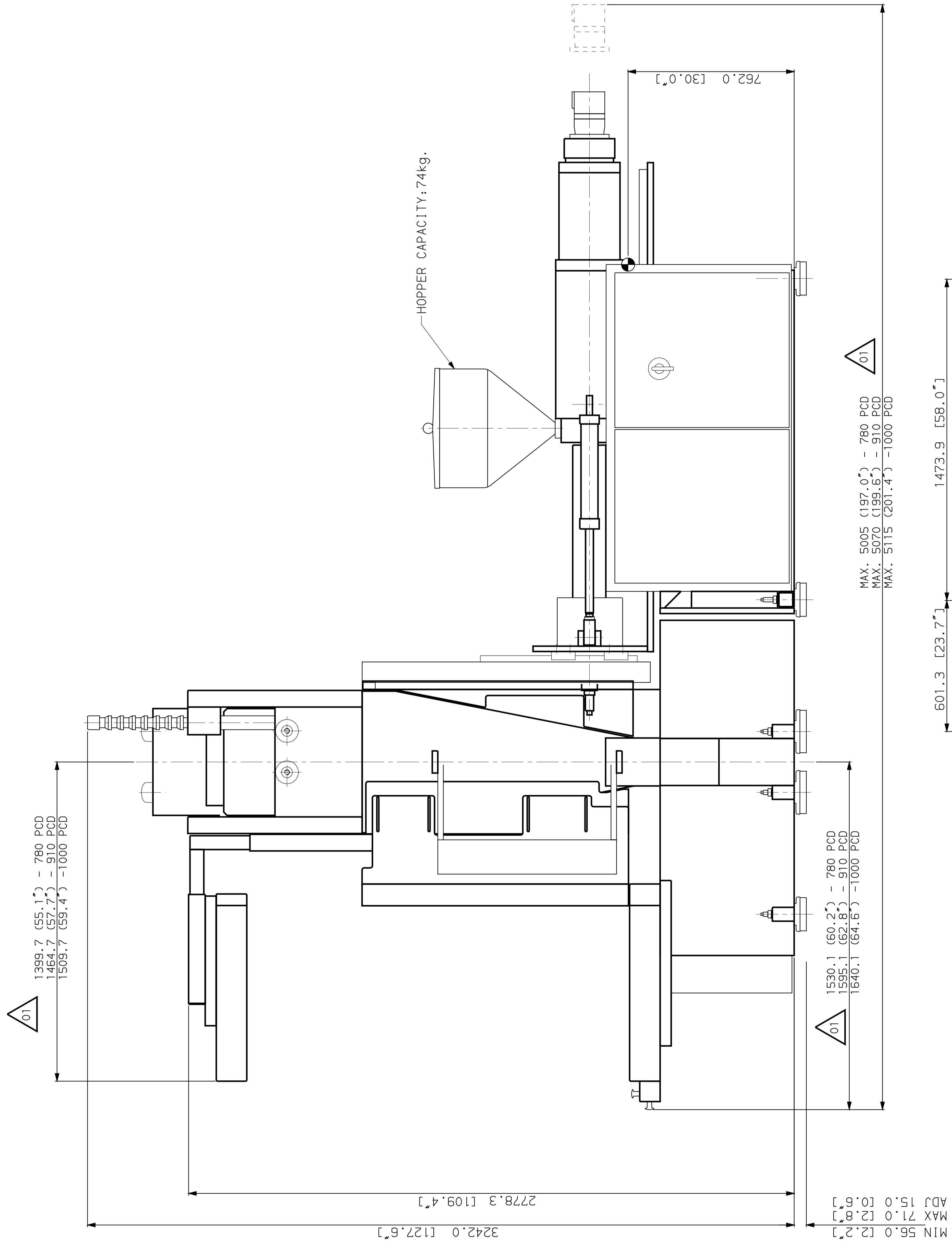

MACHINE MOUNT DETAIL (OPTIONAL)

TYPIC IM51 (6 PLACES), MAXIMUM LOAD 1364 kg.
TYPIC IM61 (4 PLACES), MAXIMUM LOAD 2727 kg.

SCALE 1:2

LEGEND

- MACHINE MOUNT
- STD. ELE. UTILITY ENTRANCE
- AIR CONN. -3/8" NPT.
- COOLING WATER CONN. IN & OUT 3/4" NPT

WEIGHT OF MACHINE
17,000 kg (APPROX.)
[37,400 lb]

NOTES:

1. ALL DIMENSIONS ARE IN MILLIMETER AND [INCH].
2. TECHNICAL DATA ARE SUBJECT TO CHANGE WITHOUT NOTICE.

REV.	DATE	BY	CHK'D	APP'D
1	19-01-00			
2	19-01-00			
3	19-01-00			
4	19-01-00			
5	19-01-00			
6	19-01-00			
7	19-01-00			
8	19-01-00			
9	19-01-00			
10	19-01-00			
11	19-01-00			
12	19-01-00			
13	19-01-00			
14	19-01-00			
15	19-01-00			
16	19-01-00			
17	19-01-00			
18	19-01-00			
19	19-01-00			
20	19-01-00			
21	19-01-00			
22	19-01-00			
23	19-01-00			
24	19-01-00			
25	19-01-00			
26	19-01-00			
27	19-01-00			
28	19-01-00			
29	19-01-00			
30	19-01-00			
31	19-01-00			
32	19-01-00			
33	19-01-00			
34	19-01-00			
35	19-01-00			
36	19-01-00			
37	19-01-00			
38	19-01-00			
39	19-01-00			
40	19-01-00			
41	19-01-00			
42	19-01-00			
43	19-01-00			
44	19-01-00			
45	19-01-00			
46	19-01-00			
47	19-01-00			
48	19-01-00			
49	19-01-00			
50	19-01-00			
51	19-01-00			
52	19-01-00			
53	19-01-00			
54	19-01-00			
55	19-01-00			
56	19-01-00			
57	19-01-00			
58	19-01-00			
59	19-01-00			
60	19-01-00			
61	19-01-00			
62	19-01-00			
63	19-01-00			
64	19-01-00			
65	19-01-00			
66	19-01-00			
67	19-01-00			
68	19-01-00			
69	19-01-00			
70	19-01-00			
71	19-01-00			
72	19-01-00			
73	19-01-00			
74	19-01-00			
75	19-01-00			
76	19-01-00			
77	19-01-00			
78	19-01-00			
79	19-01-00			
80	19-01-00			
81	19-01-00			
82	19-01-00			
83	19-01-00			
84	19-01-00			
85	19-01-00			
86	19-01-00			
87	19-01-00			
88	19-01-00			
89	19-01-00			
90	19-01-00			
91	19-01-00			
92	19-01-00			
93	19-01-00			
94	19-01-00			
95	19-01-00			
96	19-01-00			
97	19-01-00			
98	19-01-00			
99	19-01-00			
100	19-01-00			

REV.	DATE	BY	CHK'D	APP'D
1	19-01-00			
2	19-01-00			
3	19-01-00			
4	19-01-00			
5	19-01-00			
6	19-01-00			
7	19-01-00			
8	19-01-00			
9	19-01-00			
10	19-01-00			
11	19-01-00			
12	19-01-00			
13	19-01-00			
14	19-01-00			
15	19-01-00			
16	19-01-00			
17	19-01-00			
18	19-01-00			
19	19-01-00			
20	19-01-00			
21	19-01-00			
22	19-01-00			
23	19-01-00			
24	19-01-00			
25	19-01-00			
26	19-01-00			
27	19-01-00			
28	19-01-00			
29	19-01-00			
30	19-01-00			
31	19-01-00			
32	19-01-00			
33	19-01-00			
34	19-01-00			
35	19-01-00			
36	19-01-00			
37	19-01-00			
38	19-01-00			
39	19-01-00			
40	19-01-00			
41	19-01-00			
42	19-01-00			
43	19-01-00			
44	19-01-00			
45	19-01-00			
46	19-01-00			
47	19-01-00			
48	19-01-00			
49	19-01-00			
50	19-01-00			
51	19-01-00			
52	19-01-00			
53	19-01-00			
54	19-01-00			
55	19-01-00			
56	19-01-00			
57	19-01-00			
58	19-01-00			
59	19-01-00			
60	19-01-00			
61	19-01-00			
62	19-01-00			
63	19-01-00			
64	19-01-00			
65	19-01-00			
66	19-01-00			
67	19-01-00			
68	19-01-00			
69	19-01-00			
70	19-01-00			
71	19-01-00			
72	19-01-00			
73	19-01-00			
74	19-01-00			
75	19-01-00			
76	19-01-00			
77	19-01-00			
78	19-01-00			
79	19-01-00			
80	19-01-00			
81	19-01-00			
82	19-01-00			
83	19-01-00			
84	19-01-00			
85	19-01-00			
86	19-01-00			
87	19-01-00			
88	19-01-00			
89	19-01-00			
90	19-01-00			
91	19-01-00			
92	19-01-00			
93	19-01-00			
94	19-01-00			
95	19-01-00			
96	19-01-00			
97	19-01-00			
98	19-01-00			
99	19-01-00			
100	19-01-00			

REV.	DATE	BY	CHK'D	APP'D
1	19-01-00			
2	19-01-00			
3	19-01-00			
4	19-01-00			
5	19-01-00			
6	19-01-00			
7	19-01-00			
8	19-01-00			
9	19-01-00			
10	19-01-00			
11	19-01-00			
12	19-01-00			
13	19-01-00			
14	19-01-00			
15	19-01-00			
16	19-01-00			
17	19-01-00			
18	19-01-00			
19	19-01-00			
20	19-01-00			
21	19-01-00			
22	19-01-00			
23	19-01-00			
24	19-01-00			
25	19-01-00			
26	19-01-00			
27	19-01-00			
28	19-01-00			
29	19-01-00			
30	19-01-00			
31	19-01-00			
32	19-01-00			
33	19-01-00			
34	19-01-00			
35	19-01-00			
36	19-01-00			
37	19-01-00			
38	19-01-00			
39	19-01-00			
40	19-01-00			
41	19-01-00			
42	19-01-00			
43	19-01-00			
44	19-01-00			
45	19-01-00			

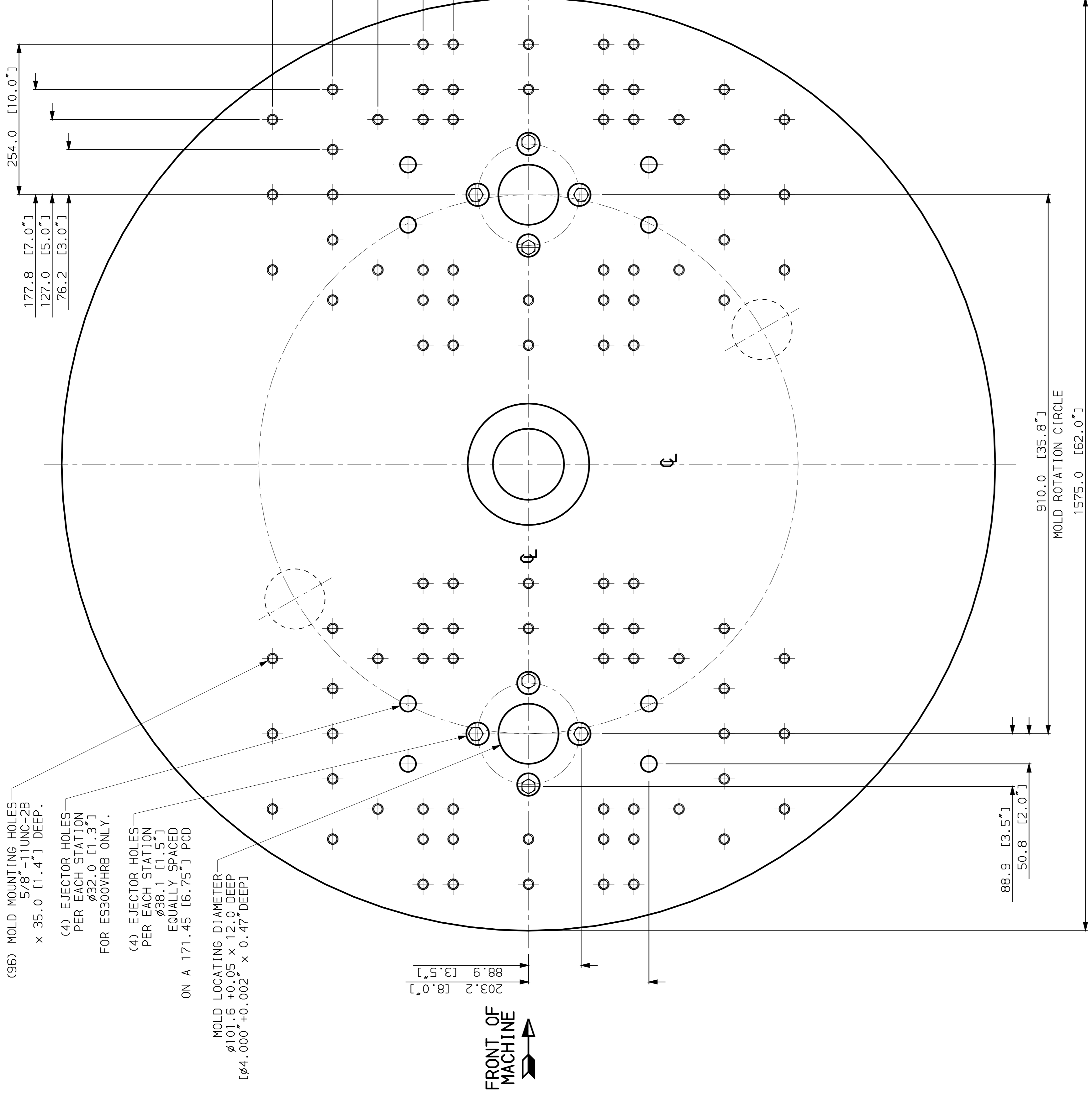

VIEW-A

VIEW AT TOP OF TWO STATION TABLE

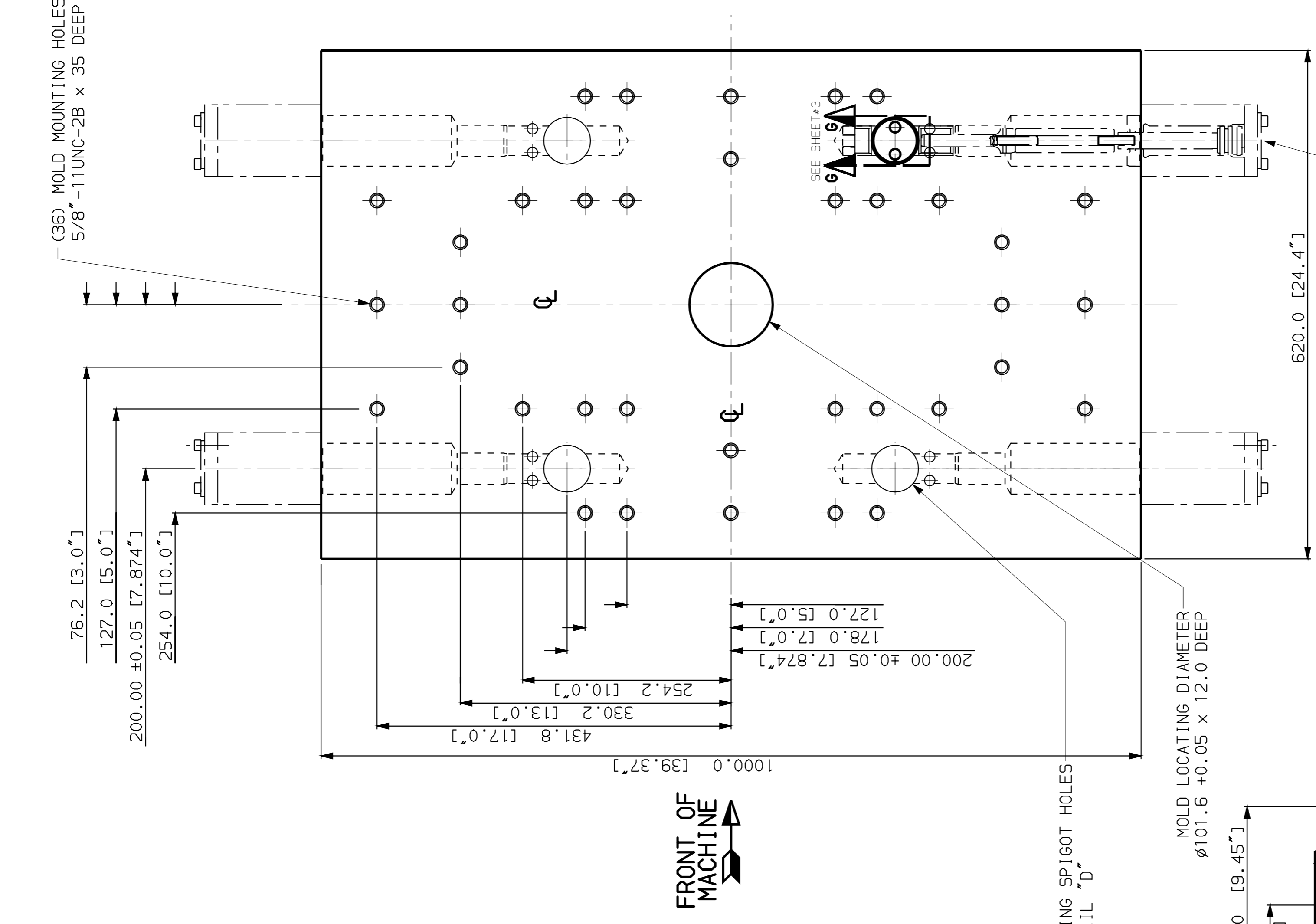

VIEW-B

VIEW AT MOLD MOUNTING SURFACE OF MOVING PLATEN

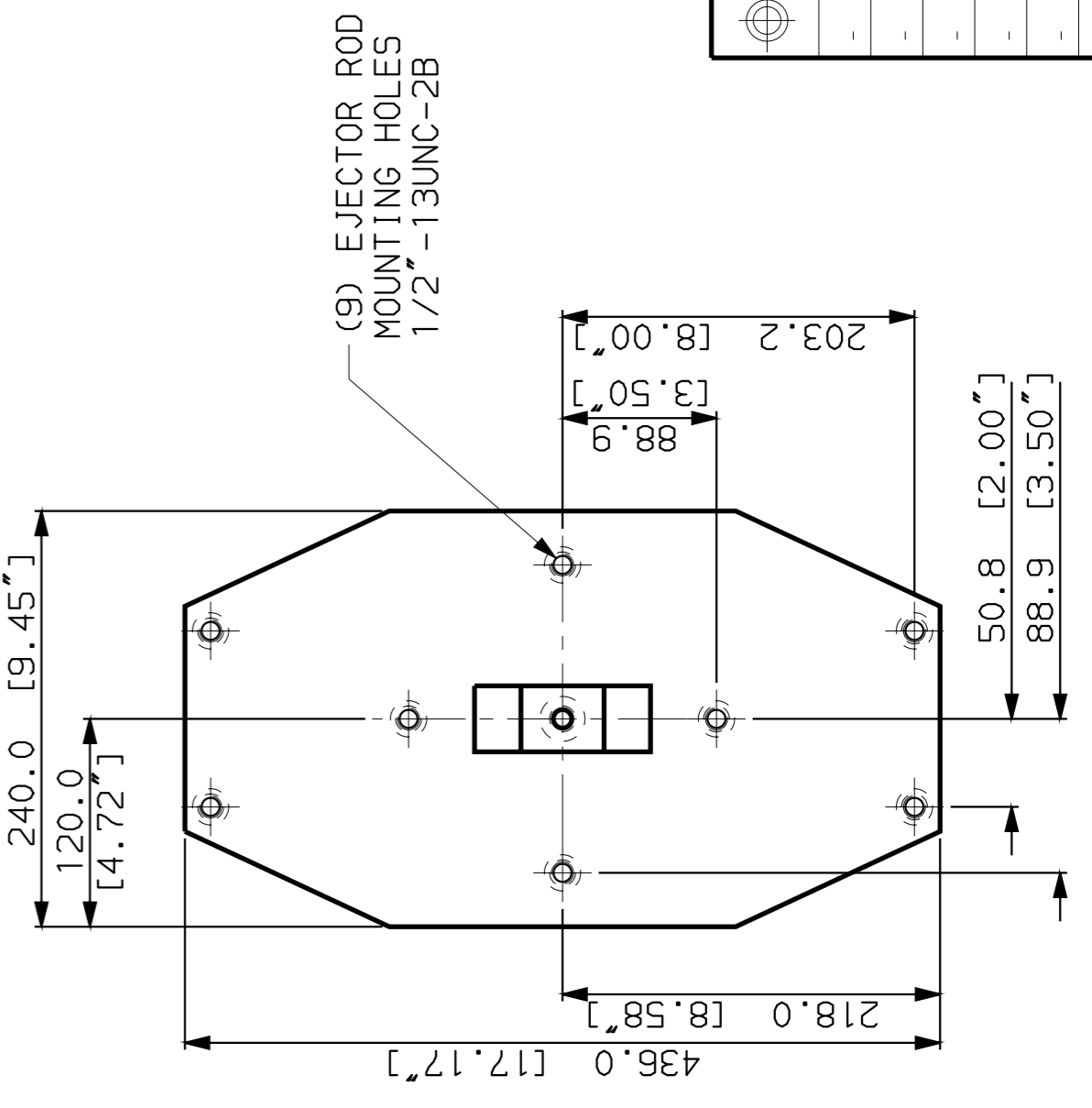

VIEW-E

VIEW AT EJECTOR PLATE

RELEASED
MICROFILM
REV. # 1

NOTES:
1) DIMENSIONS ARE SYMMETRICAL ABOUT ϕ UNLESS OTHERWISE SHOWN.

REV. #	DATE	DESCRIPTION	BY	CHK'D	DATE
1	10-JUNE-2002	157501A.PCD910MM 2 STN.			
2	16-OCT-00				
3	16-OCT-00				
4	16-OCT-00				

SCALE	1:4
MATERIAL	PLATEN LAYOUT 200VHRB
STOCK CODE #	157501A.PCD910MM 2 STN.
DR. N.	
LIV. U. P.	
CHK'D	
A. D.	
DATE	

SIZE	30	120	315	1000	2000
FROM	0.5	1.20	3.15	10.00	20.00
B. S.	0.5	1.20	3.15	10.00	20.00
FINE #	0.05	0.1	0.15	0.2	0.3
MED. #	0.1	0.2	0.3	0.5	0.8
MICRO	0.1	0.2	0.3	0.5	0.8
DIM.	0.2	0.5	0.8	1.2	2.0
METERS	0.2	0.5	0.8	1.2	2.0
COARSE #	0.2	0.5	0.8	1.2	2.0
COARSE	0.2	0.5	0.8	1.2	2.0

REPLACES	5620.002.22690 VER.#12
COPY FROM	5620.002.22690 VER.#12
REV. #	1
DATE	10-JUNE-2002
BY	
CHK'D	
A. D.	
DATE	

5620.002.12590
SHEET 2 OF 3
REV. # 1

THIS DRAWING AND THE INFORMATION HEREIN IS CONFIDENTIAL AND NOT TO BE DISCLOSED OR REPRODUCED WITHOUT WRITTEN PERMISSION OF ENGEL CANADA INC.

PART WEIGHT IN KG: -

ENGEL
GUELPHI - CANADA

RELEASED
MICROFILM
REV. # 1

NOTES:
1) DIMENSIONS ARE SYMMETRICAL ABOUT ϕ UNLESS OTHERWISE SHOWN.

